

MOSFETs Silicon N-Channel MOS (π -MOSVII)

TK4P60DB

1. Applications

- Switching Voltage Regulators

2. Features

- (1) Low drain-source on-resistance : $R_{DS(ON)} = 1.6 \Omega$ (typ.)
- (2) High forward transfer admittance : $|Y_{fs}| = 2.2 \text{ S}$ (typ.)
- (3) Low leakage current : $I_{DSS} = 10 \mu\text{A}$ (max) ($V_{DS} = 600 \text{ V}$)
- (4) Enhancement mode : $V_{th} = 2.4 \text{ to } 4.4 \text{ V}$ ($V_{DS} = 10 \text{ V}$, $I_D = 1 \text{ mA}$)

3. Packaging and Internal Circuit

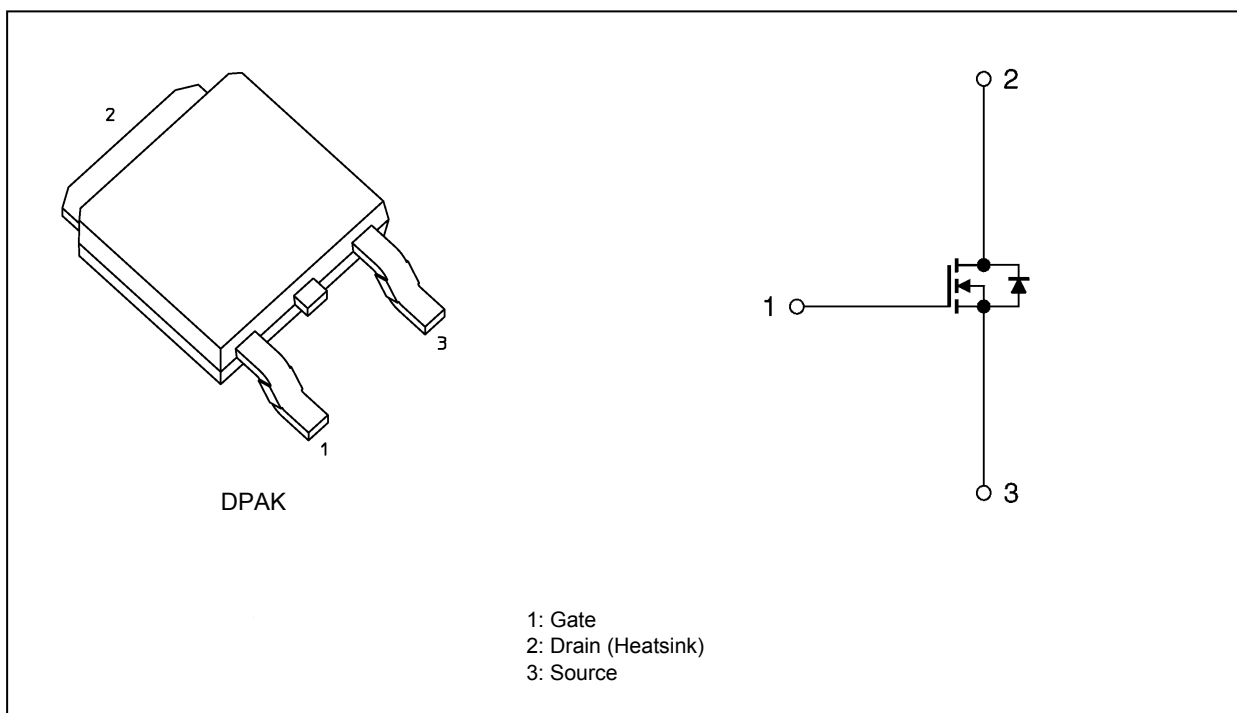

Start of commercial production

2009-12

2015-03-05

Rev.1.0

4. Absolute Maximum Ratings (Note) ($T_a = 25\text{ }^\circ\text{C}$ unless otherwise specified)

Characteristics	Symbol	Rating	Unit
Drain-source voltage	V_{DSS}	600	V
Gate-source voltage	V_{GSS}	± 30	
Drain current (DC) (Note 1)	I_D	3.7	A
Drain current (pulsed) (Note 1)	I_{DP}	14.8	
Power dissipation ($T_c = 25\text{ }^\circ\text{C}$)	P_D	80	W
Single-pulse avalanche energy (Note 2)	E_{AS}	147	mJ
Avalanche current (Note 3)	I_{AR}	3.7	A
Repetitive avalanche energy (Note 3)	E_{AR}	8	mJ
Reverse drain current (DC) (Note 1)	I_{DR}	3.7	A
Reverse drain current (pulsed) (Note 1)	I_{DRP}	14.8	
Channel temperature	T_{ch}	150	$^\circ\text{C}$
Storage temperature	T_{stg}	-55 to 150	

Note: Using continuously under heavy loads (e.g. the application of high temperature/current/voltage and the significant change in temperature, etc.) may cause this product to decrease in the reliability significantly even if the operating conditions (i.e. operating temperature/current/voltage, etc.) are within the absolute maximum ratings.

5. Thermal Characteristics

Characteristics	Symbol	Max	Unit
Channel-to-case thermal resistance	$R_{th(ch-c)}$	1.56	$^\circ\text{C}/\text{W}$
Channel-to-ambient thermal resistance	$R_{th(ch-a)}$	125	

Note 1: Ensure that the channel temperature does not exceed $150\text{ }^\circ\text{C}$.

Note 2: $V_{DD} = 90\text{ V}$, $T_{ch} = 25\text{ }^\circ\text{C}$ (initial), $L = 18.7\text{ mH}$, $R_G = 25\text{ }\Omega$, $I_{AR} = 3.7\text{ A}$

Note 3: Repetitive rating; pulse width limited by maximum channel temperature.

Note: This transistor is sensitive to electrostatic discharge and should be handled with care.

6. Electrical Characteristics

6.1. Static Characteristics ($T_a = 25\text{ }^\circ\text{C}$ unless otherwise specified)

Characteristics	Symbol	Test Condition	Min	Typ.	Max	Unit
Gate leakage current	I_{GSS}	$V_{GS} = \pm 30\text{ V}, V_{DS} = 0\text{ V}$	—	—	± 1	μA
Drain cut-off current	I_{DSS}	$V_{DS} = 600\text{ V}, V_{GS} = 0\text{ V}$	—	—	10	
Drain-source breakdown voltage	$V_{(BR)DSS}$	$I_D = 10\text{ mA}, V_{GS} = 0\text{ V}$	600	—	—	V
Gate threshold voltage	V_{th}	$V_{DS} = 10\text{ V}, I_D = 1\text{ mA}$	2.4	—	4.4	
Drain-source on-resistance	$R_{DS(ON)}$	$V_{GS} = 10\text{ V}, I_D = 1.9\text{ A}$	—	1.6	2	Ω
Forward transfer admittance	$ Y_{fs} $	$V_{DS} = 10\text{ V}, I_D = 1.9\text{ A}$	0.6	2.2	—	S

6.2. Dynamic Characteristics ($T_a = 25\text{ }^\circ\text{C}$ unless otherwise specified)

Characteristics	Symbol	Test Condition	Min	Typ.	Max	Unit
Input capacitance	C_{iss}	$V_{DS} = 25\text{ V}, V_{GS} = 0\text{ V},$ $f = 1\text{ MHz}$	—	540	—	μF
Reverse transfer capacitance	C_{rss}		—	3	—	
Output capacitance	C_{oss}		—	60	—	
Switching time (rise time)	t_r	See Fig.6.2.1	—	18	—	ns
Switching time (turn-on time)	t_{on}		—	40	—	
Switching time (fall time)	t_f		—	8	—	
Switching time (turn-off time)	t_{off}		—	55	—	

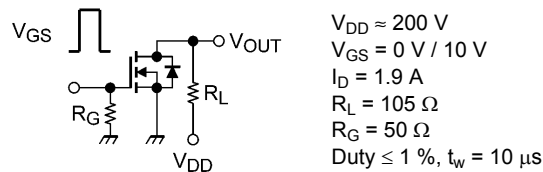

Fig. 6.2.1 Switching Time Test Circuit

6.3. Gate Charge Characteristics ($T_a = 25\text{ }^\circ\text{C}$ unless otherwise specified)

Characteristics	Symbol	Test Condition	Min	Typ.	Max	Unit
Total gate charge (gate-source plus gate-drain)	Q_g	$V_{DD} \approx 400\text{ V}, V_{GS} = 10\text{ V},$ $I_D = 3.7\text{ A}$	—	11	—	nC
Gate-source charge	Q_{gs}		—	6	—	
Gate-drain charge	Q_{gd}		—	5	—	

6.4. Source-Drain Characteristics ($T_a = 25\text{ }^\circ\text{C}$ unless otherwise specified)

Characteristics	Symbol	Test Condition	Min	Typ.	Max	Unit
Diode forward voltage	V_{DSF}	$I_{DR} = 3.7\text{ A}, V_{GS} = 0\text{ V}$	—	—	-1.7	V
Reverse recovery time	t_{rr}	$I_{DR} = 3.7\text{ A}, V_{GS} = 0\text{ V},$ $-di/dt = 100\text{ A}/\mu\text{s}$	—	1000	—	ns
Reverse recovery charge	Q_{rr}		—	5.5	—	μC

7. Marking

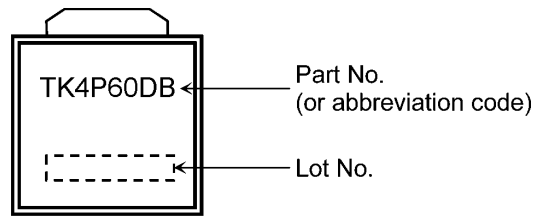

Fig. 7.1 Marking

8. Characteristics Curves (Note)

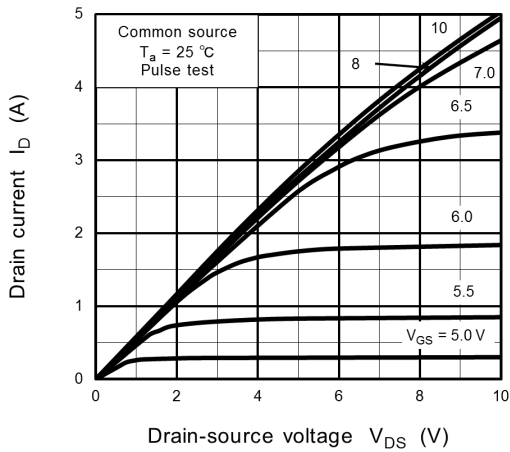

Fig. 8.1 $I_D - V_{DS}$

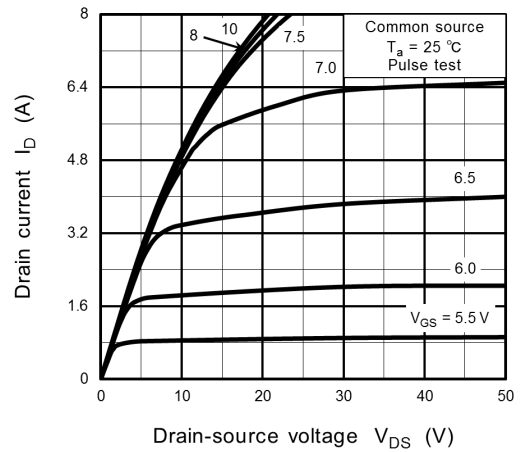

Fig. 8.2 $I_D - V_{DS}$

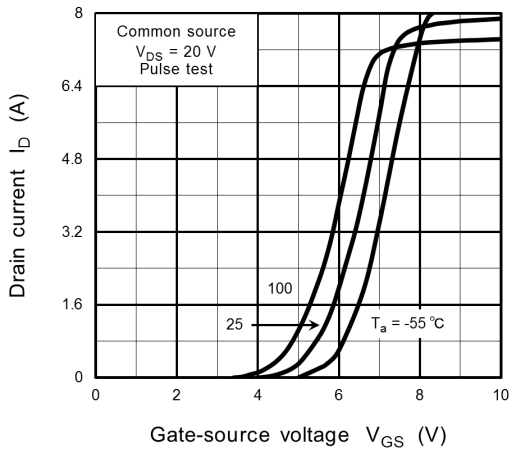

Fig. 8.3 $I_D - V_{GS}$

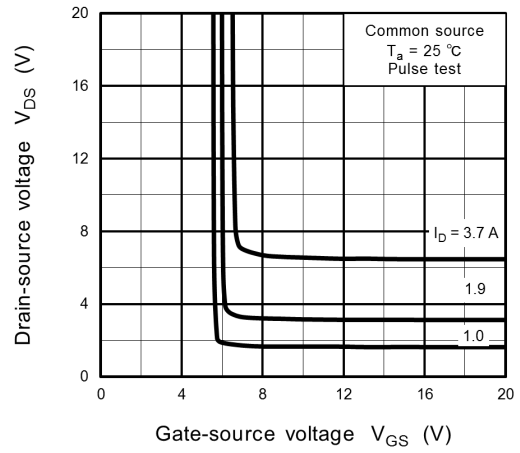

Fig. 8.4 $V_{DS} - V_{GS}$

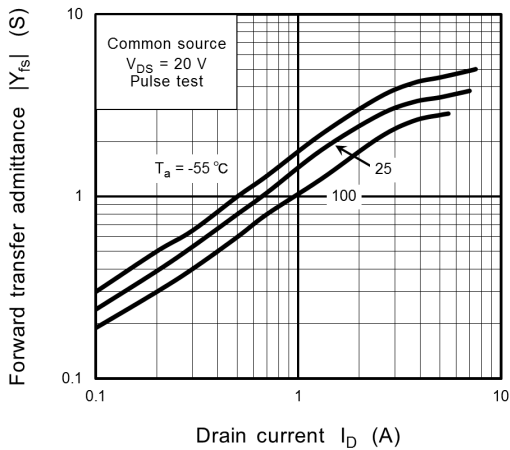

Fig. 8.5 $|Y_{fs}| - I_D$

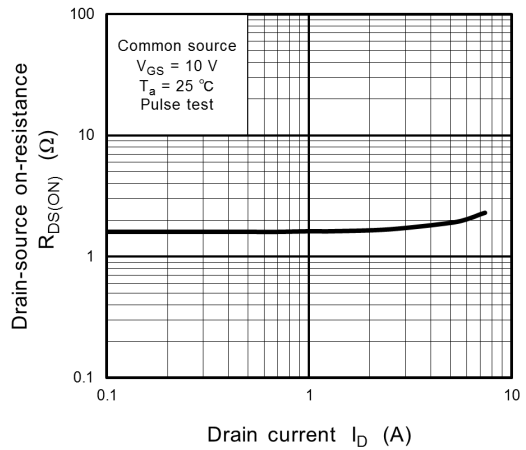

Fig. 8.6 $R_{DS(ON)} - I_D$

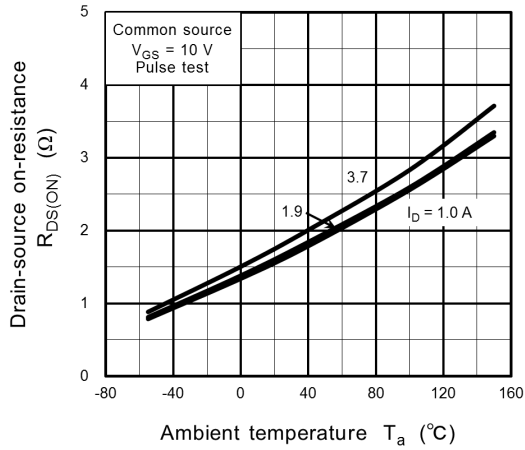

Fig. 8.7 $R_{DS(ON)} - T_a$

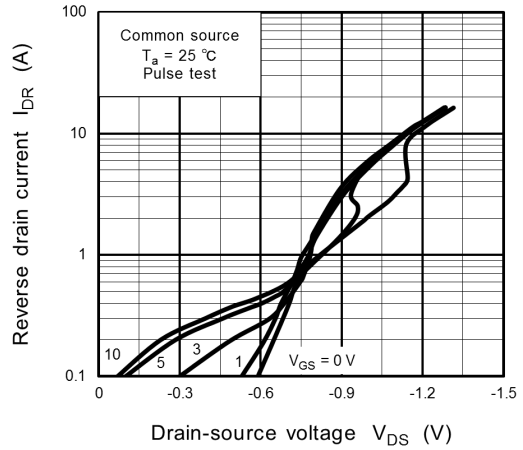

Fig. 8.8 $I_{DR} - V_{DS}$

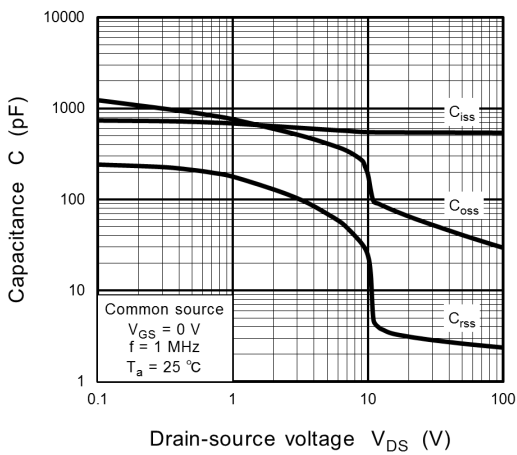

Fig. 8.9 $C - V_{DS}$

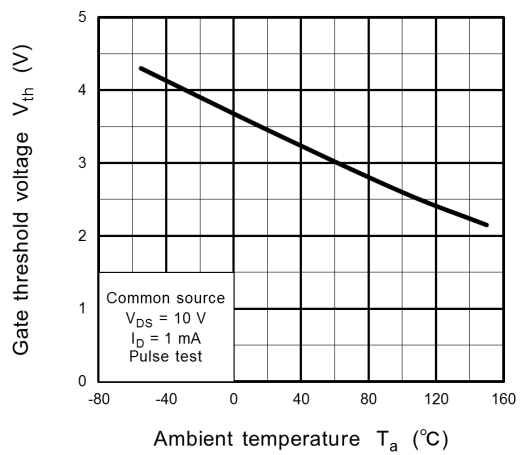

Fig. 8.10 $V_{th} - T_a$

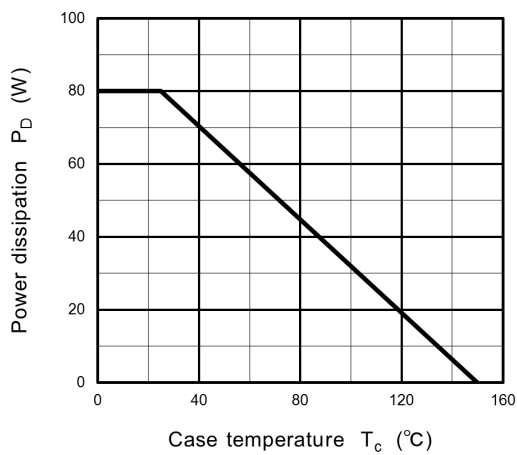

Fig. 8.11 $P_D - T_c$
 (Guaranteed Maximum)

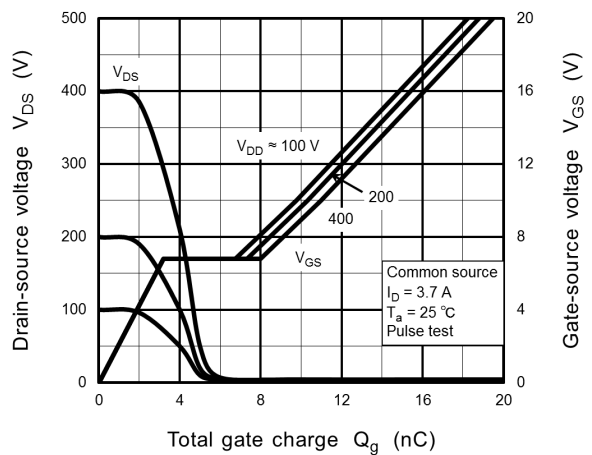

Fig. 8.12 Dynamic Input/Output Characteristics

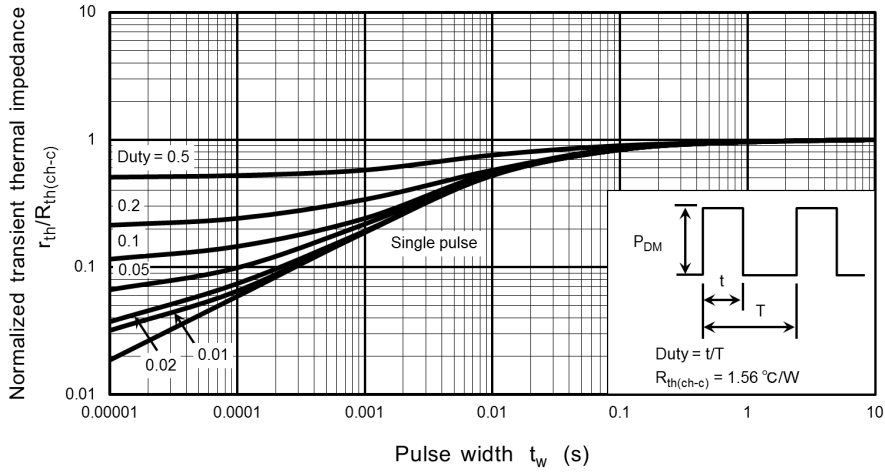

Fig. 8.13 $r_{th}/R_{th(ch-c)} - t_w$ (Guaranteed Maximum)

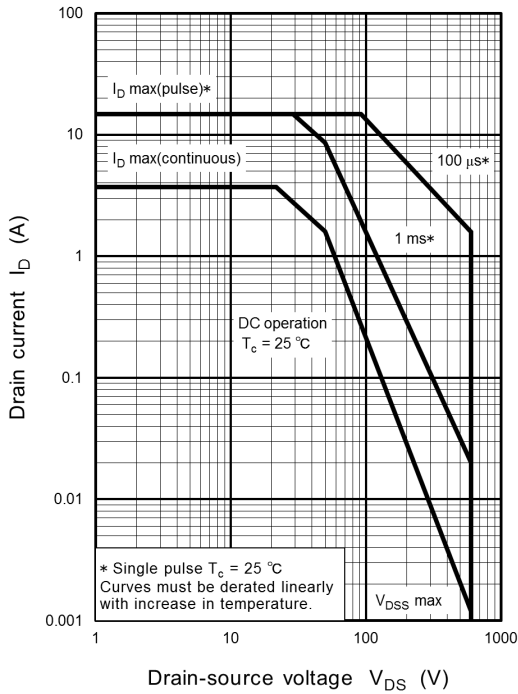

Fig. 8.14 Safe Operating Area (Guaranteed Maximum)

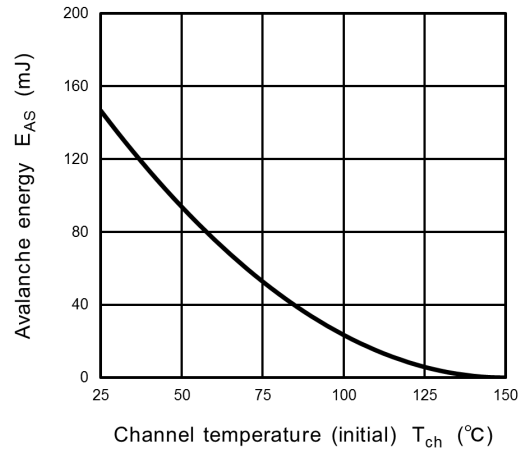
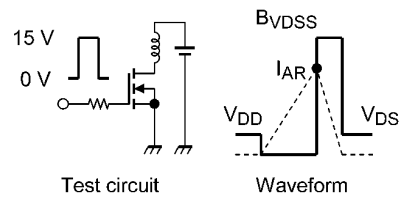

Fig. 8.15 $E_{AS} - T_{ch}$ (Guaranteed Maximum)



$$R_G = 25 \Omega, V_{DD} = 90 \text{ V} \quad E_{AS} = \frac{1}{2} \cdot L \cdot I_{AR}^2 \cdot \left(\frac{B_{VDSS}}{B_{VDSS} - V_{DD}} \right)$$

Fig. 8.16 Test Circuit/Waveform

Note: The above characteristics curves are presented for reference only and not guaranteed by production test, unless otherwise noted.

Package Dimensions

Unit: mm

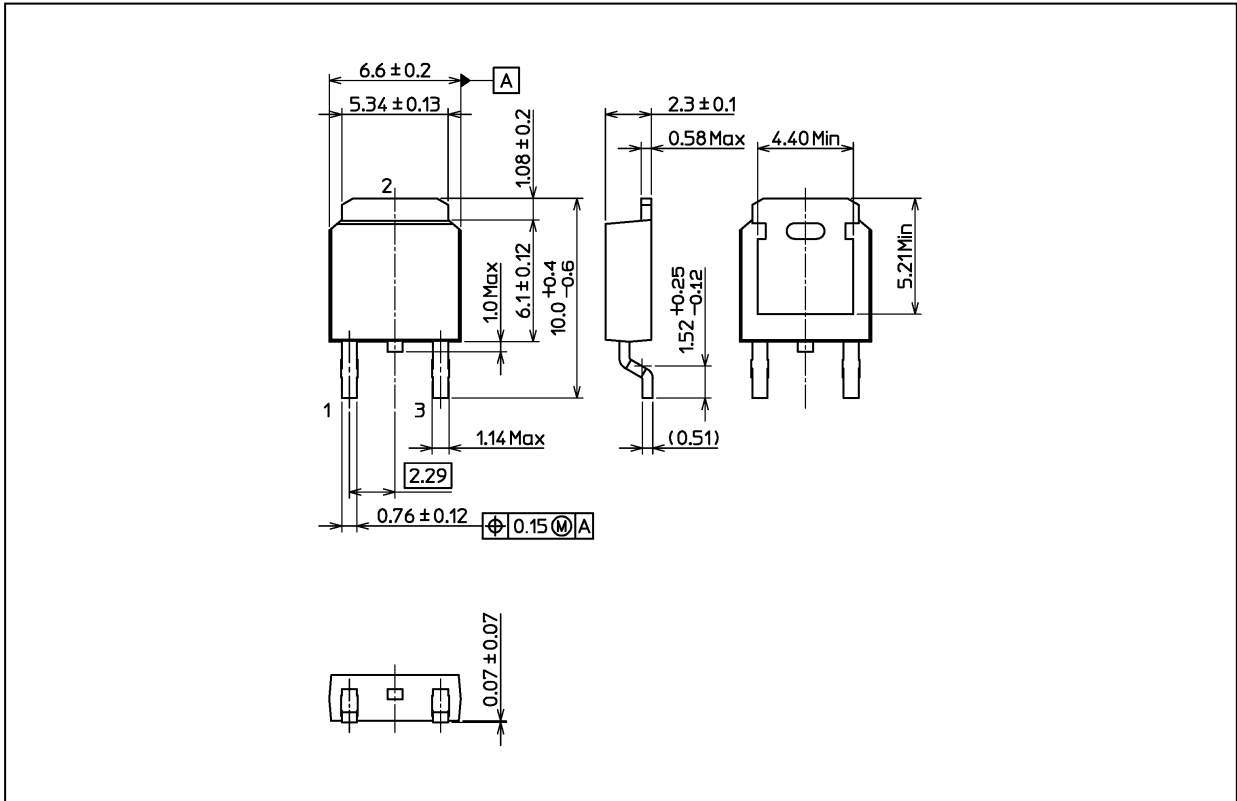

Both products are compliant with the JEDEC: TO-252 Package specification.

Weight: 0.36 g (typ.)

Package Dimensions

Unit: mm

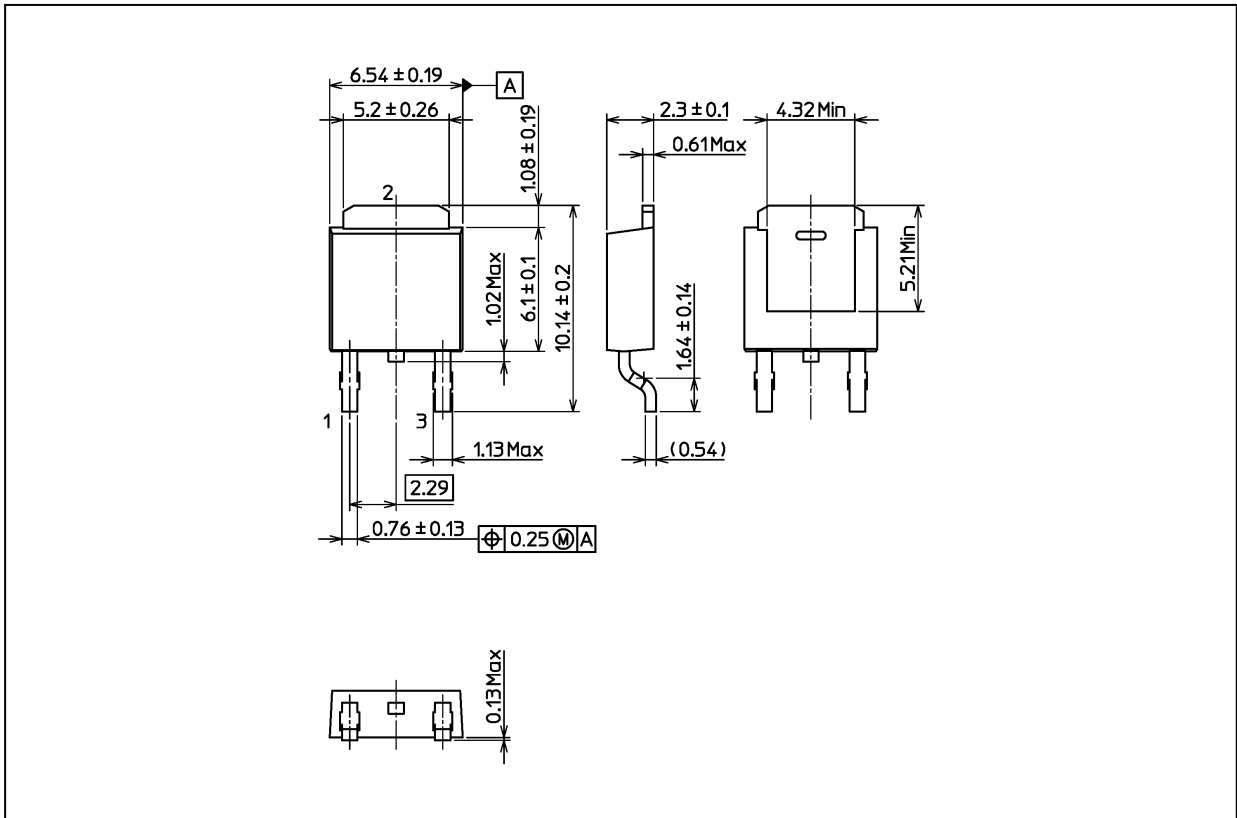

Both products are compliant with the JEDEC: TO-252 Package specification.

Weight: 0.389 g (typ.)