

DESCRIPTION

The 50N03 uses advanced trench technology

And design to provide excellent $R_{DS(ON)}$ with

Low gate charge . It can be used in a wide

Vanety of applications .

V_{DS}	$R_{DS(ON)}$	I_D
30V	--	50A

GENERAL FEATURES

- $V_{DS} = 30\text{ V}$, $I_D = 50\text{ A}$
 $R_{DS(ON)} < 6.5\text{ m}\Omega @ V_{GS} = 10\text{ V}$
- High density cell design for ultra low R_{dson}
- Fully characterized Avalanche voltage and current
- Good stability and unifomity with high EAS
- Excellent package for good heat dissipation
- Special process technology for high ESD capability

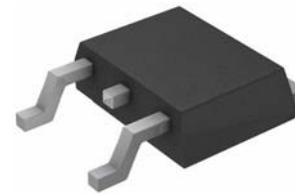

TO-252

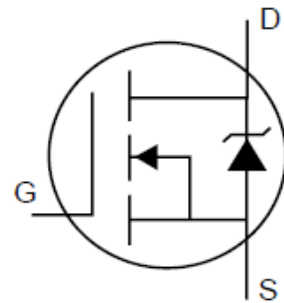

Application

- Power switching application
- Hard Switched and High Frequency Circuits
- Uninterruptible Power Supply

Absolute Maximum Ratings (TC=25°C, unless otherwise noted)

Symbol	Parameter	50N03	Units
V _{DS}	Drain-to-Source Voltage	30	V
I _D	Continuous Drain Current	50	A
	Drain Current-Continuous(Tc=100°C)	35	
I _{DM}	Pulsed Drain Current	140	
P _D	Power Dissipation	60	W
V _{GS}	Gate-to-Source Voltage	± 20	V
E _{AS}	Single Pulse Avalanche Energy	70	mJ
T _J and T _{STG}	Operating Junction and Storage Temperature Range	-55 to 175	°C

Thermal Resistance

Symbol	Parameter	Min.	Typ.	Max.	Units	Test Conditions
R _{θJC}	Junction-to-Case	--	--	2.5	°C/W	Water cooled heatsink, P _D adjusted for a peak junction temperature of +175°C.

OFF Characteristics T_J=25°C unless otherwise specified

Symbol	Parameter	Min.	Typ.	Max.	Units	Test Conditions
B _V D _{SS}	Drain-to-Source Breakdown Voltage	30	33	--	V	V _{GS} =0, I _D =250μA
I _{GSS}	Gate-to-Source Forward Leakage	--	--	±100	nA	V _{DS} =0V, V _{GS} =±20V
I _{DSS}	Zero Gate Voltage Drain Current	--	--	1	μA	V _{DS} =30V, V _{GS} =0V

ON Characteristics T_J=25°C unless otherwise specified

Symbol	Parameter	Min.	Typ.	Max	Units	Test Conditions
R _{DS(ON)}	Static Drain-to-Source On-Resistance	--	5.9	6.5	mΩ	V _{GS} =10V, I _D =25A
V _{GS(TH)}	Gate Threshold Voltage, Figure 12.	1.0	1.5	3.0	V	V _{DS} = V _{GS} , I _D =250μA
G _{fs}	Forward Transconductance	15	---	--	S	V _{DS} =5V, I _D =20A

Dynamic Characteristics Essentially independent of operating temperature

Symbol	Parameter	Min.	Typ.	Max.	Units	Test Conditions
C _{iss}	Input Capacitance	--	2000	--	pF	V _{DS} =15V, V _{GS} =0V, f=1.0MHZ
C _{oss}	Output Capacitance	--	280	--		
C _{rss}	Reverse Transfer Capacitance	--	160	--		
Q _g	Total Gate Charge	--	23	--	nC	V _{DS} =10V, V _{GS} =10V, I _D =25A
Q _{gs}	Gate-to-Source Charge	--	7.0	--		
Q _{gd}	Gate-to-Drain ("Miller") Charge	--	4.5	--		

Drain-Source Diode Characteristics

Diode Forward Voltage	V _{SD}	V _{GS} =0V, I _S =25A	--	0.85	1.2	V
Diode Forward Current	I _S	--	--	--	40	A
Reverse Recovery Time	t _{rr}	T _J =25°C, I _F =40A Di/dt = 100 A/μs	--	22	35	nS
Reverse Recovery Charge	Q _{rr}		--	12	20	nC
Forward Turn-On Time	t _{on}	Intrinsic turn-on time is negligible (turn-on is dominated by LS+LD)				

Notes:

1. Repetitive Rating: Pulse width limited by maximum junction temperature.
2. Surface Mounted on FR4 Board, t ≤ 10 sec.
3. Pulse Test: Pulse Width ≤ 300μs, Duty Cycle ≤ 2%.
4. Guaranteed by design, not subject to production.
5. EAS condition: T_J=25°C, V_{DD}=15V, V_G=10V, L=1mH, R_g=25Ω.

Test circuit

1) E_{AS} test Circuits

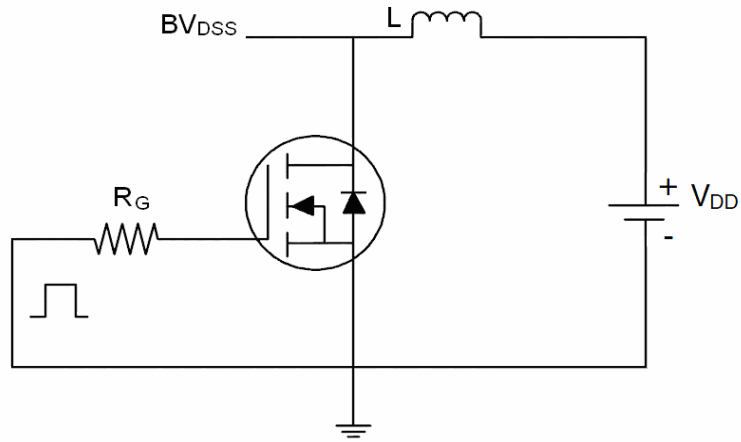

2) Gate charge test Circuit:

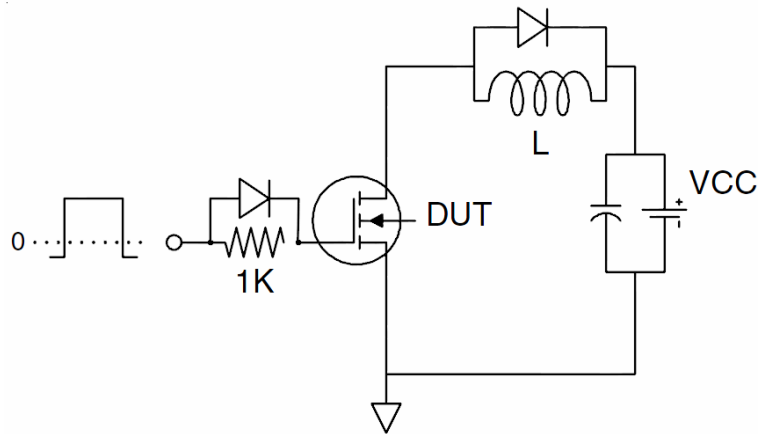

3) Switch Time Test Circuit:

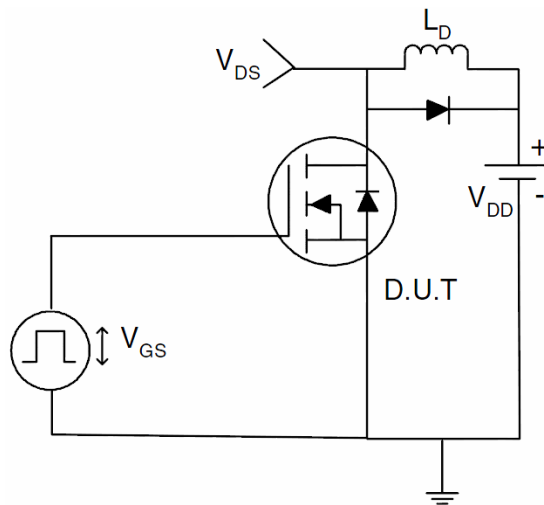

TYPICAL ELECTRICAL AND THERMAL CHARACTERISTICS (Curves)

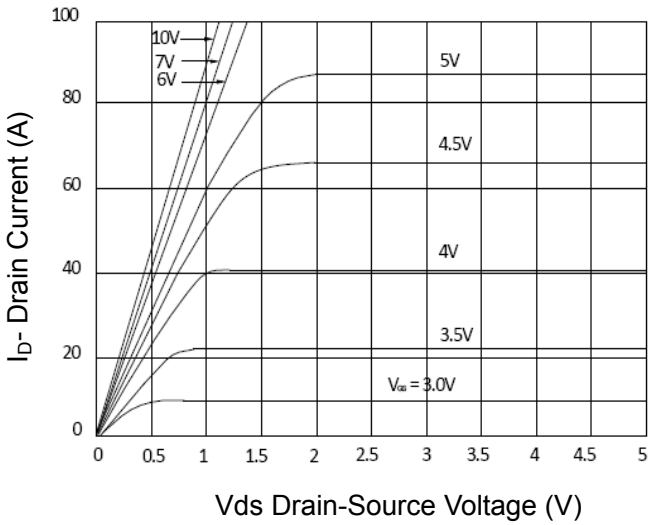

Figure 1 Output Characteristics

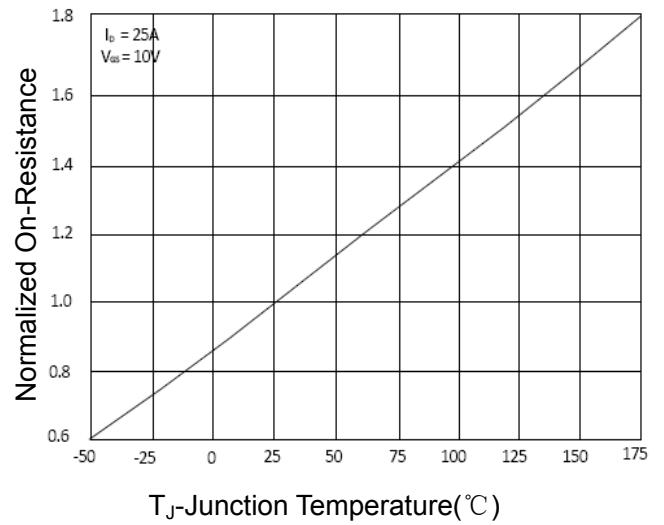

Figure 4 R_{dson} -Junction Temperature

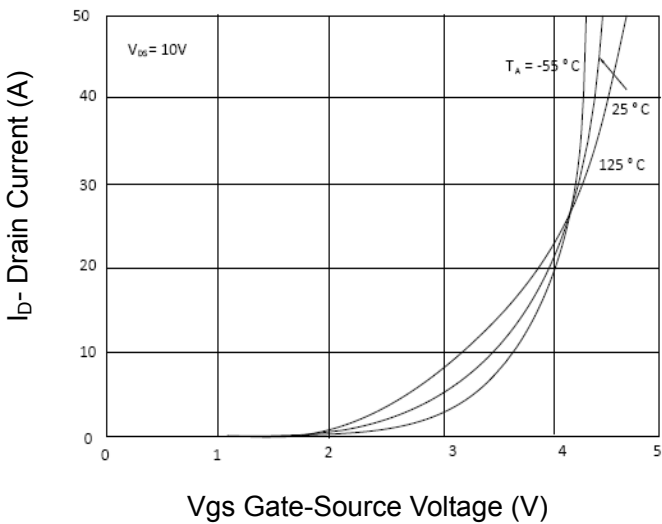

Figure 2 Transfer Characteristics

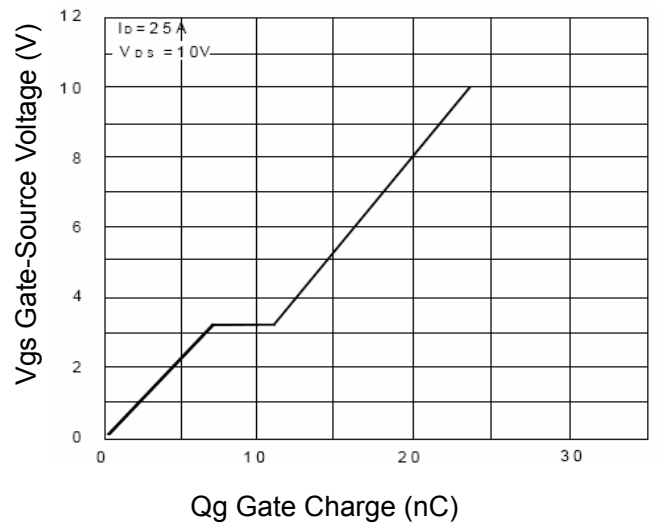

Figure 5 Gate Charge

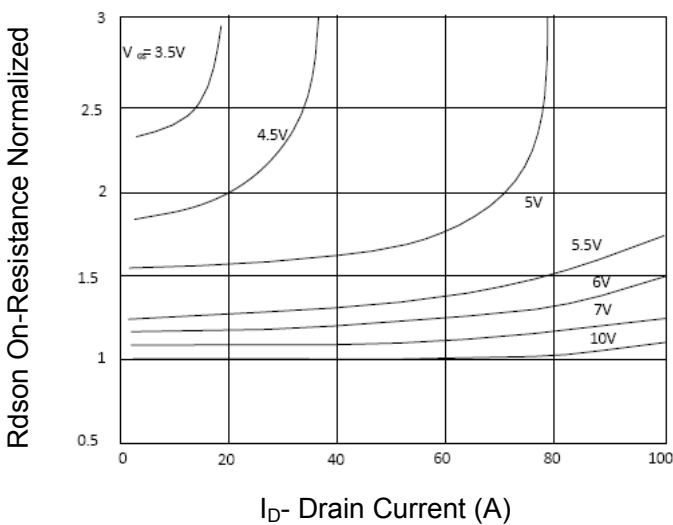

Figure 3 R_{dson} - Drain Current

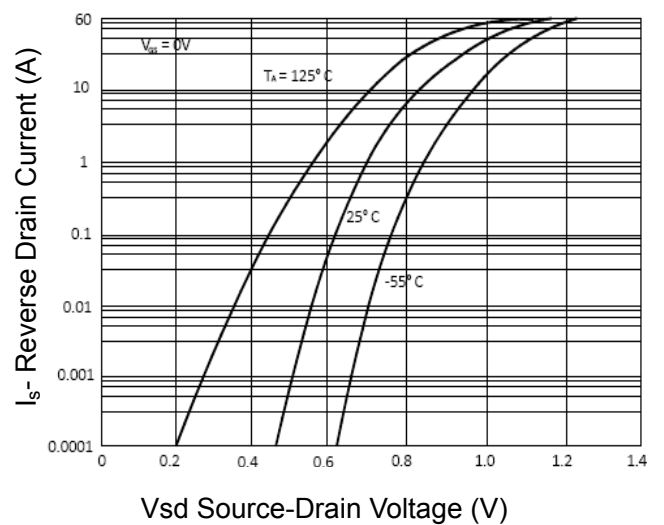
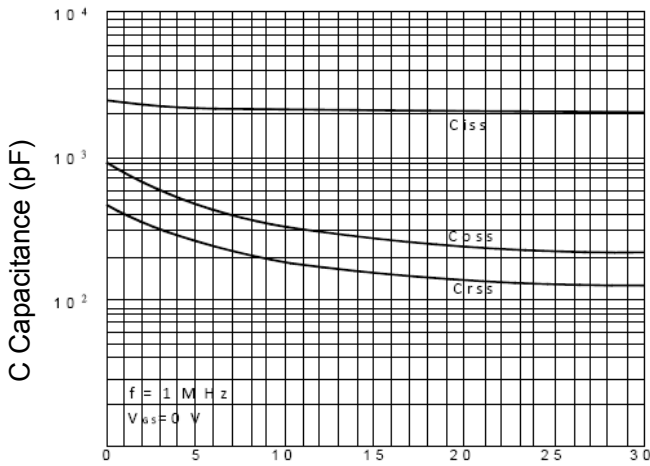
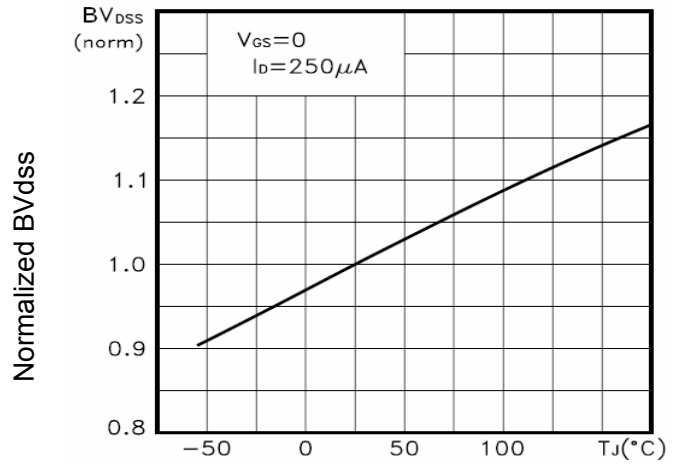

Figure 6 Source- Drain Diode Forward



Vds Drain-Source Voltage (V)
Figure 7 Capacitance vs Vds



T_J -Junction Temperature($^{\circ}C$)
Figure 9 BV_{DSS} vs Junction Temperature

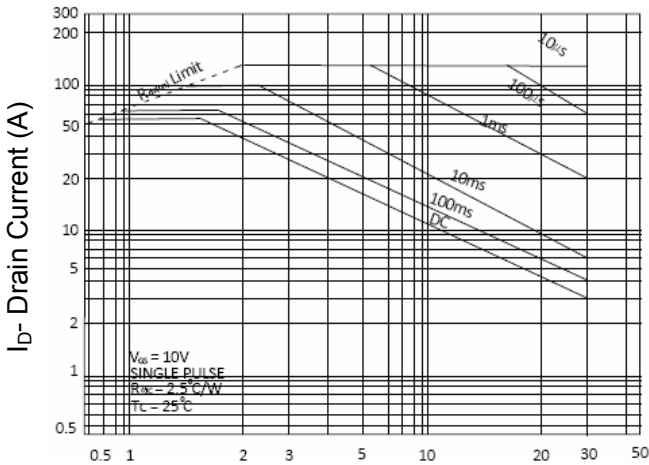

Vds Drain-Source Voltage (V)
Figure 8 Safe Operation Area

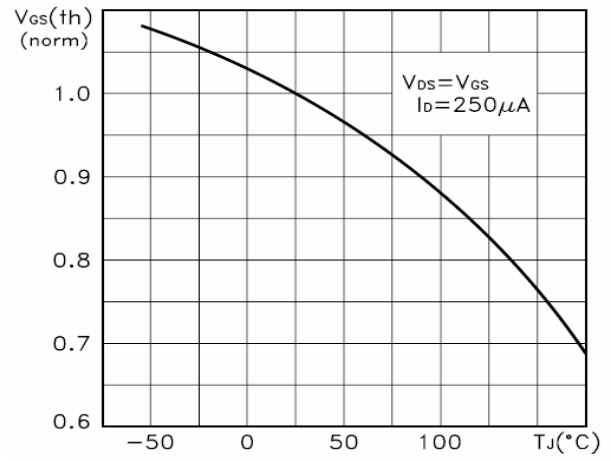

T_J -Junction Temperature($^{\circ}C$)
Figure 10 $V_{GS(th)}$ vs Junction Temperature

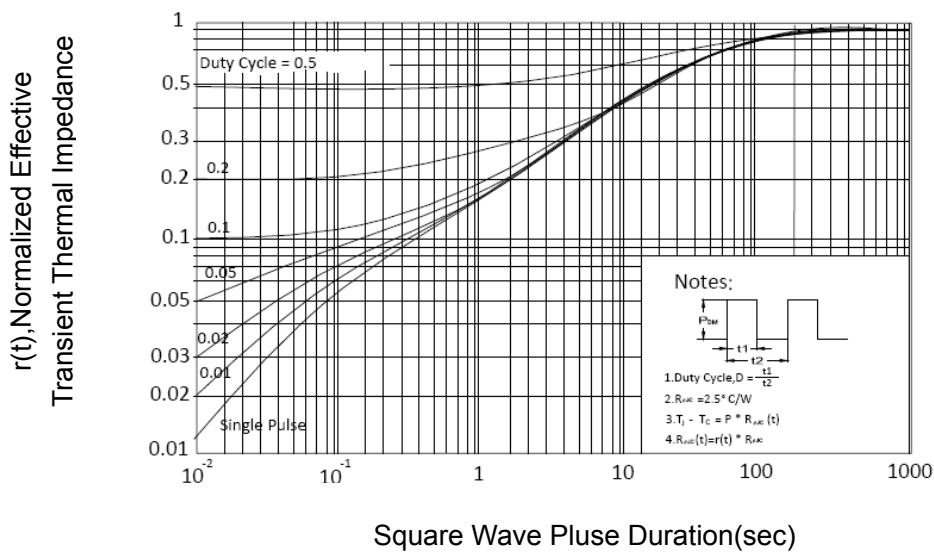

Square Wave Pulse Duration(sec)
Figure 11 Normalized Maximum Transient Thermal Impedance