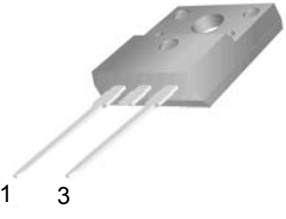
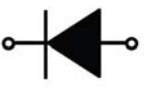

<p>MURF1005 - MURF1060</p> <p>Features:</p> <ul style="list-style-type: none"> <input type="checkbox"/> High surge capacity <input type="checkbox"/> Low Forward Voltage Drop. <input type="checkbox"/> High Current Capability. <input type="checkbox"/> Super Fast Switching Speed For High Efficiency 	<p>TO-220F -2L </p>   <p>1. Cathode 3. Anode</p>
--	--

Absolute Maximum Ratings (Ta=25°C unless otherwise noted)

Parameter	Symbol	MURF 1005	MURF 1010	MURF 1015	MURF 1020	MURF 1030	MURF 1040	MURF 1060	Unit
Maximum recurrent peak reverse voltage	V _{RRM}	50	100	150	200	300	400	600	V
Maximum RMS Voltage	V _{RMS}	35	70	105	140	210	280	420	V
Maximum DC Blocking Voltage	V _{R(DC)}	50	100	150	200	300	400	600	V
Average Rectified Forward Current Total Device, (Rated V _R), T _j = 150°C	I _{F(AV)}	10							A
Nonrepetitive Peak Surge Current(Surge applied at rated load conditions half wave, single phase, 60 Hz)	I _{FSM}	130							A
Operating Junction Temperature and Storage Temperature	T _j , T _{stg}	-55 to +155							°C
Maximum Thermal Resistance, Junction-to-Case	R _{θJC}	3.0				2.0			°C/W

ELECTRICAL CHARACTERISTICS

Parameter	Symbol	MURF 1005	MURF 1010	MURF 1015	MURF 1020	MURF 1030	MURF 1040	MURF 1060	Unit
Forward Voltage (I _F =5A, T _j = 25°C) (Note 1) (I _F =5A, T _j = 150°C)	V _F	0.975 0.895			1.30 1.00		1.50 1.20		V
Maximum Instantaneous Reverse Current (Note 1) (Rated DC Voltage, T _j = 25°C) (Rated DC Voltage, T _j = 150°C)	I _R	5 250			10 500			μA	
Maximum Reverse Recovery Time (I _F = 1.0 A, di/dt = 50 A/μs) (I _F = 0.5 A, I _R = 1.0 A, I _{REC} = 0.25 A)	T _{RR}	35 25			60 50			ns	

Note 1.Pulse Test: Pulse Width = 300 μs, Duty Cycle ≤2.0%

Typical Characteristics

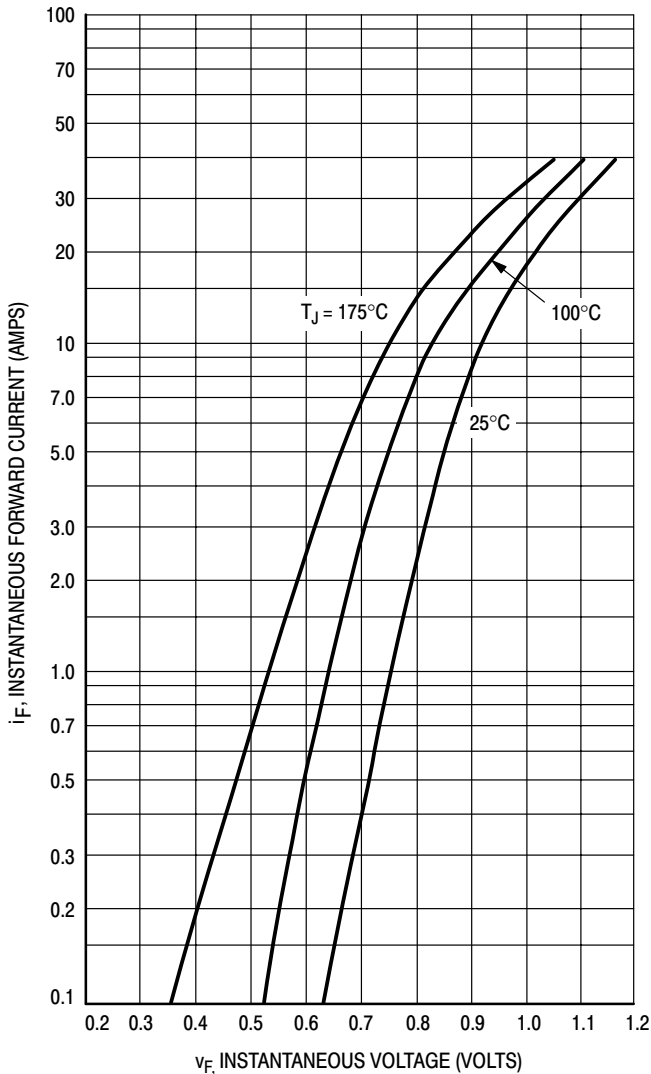

Figure 1. Typical Forward Voltage, Per Leg

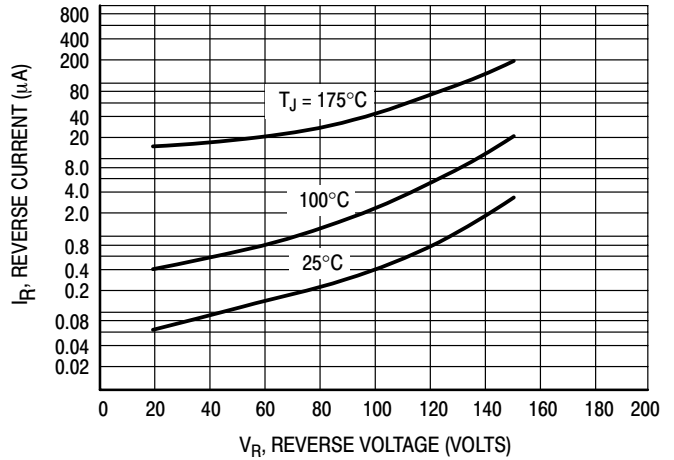

Figure 2. Typical Reverse Current, Per Leg*

* The curves shown are typical for the highest voltage device in the voltage grouping. Typical reverse current for lower voltage selections can be estimated from these same curves if V_R is sufficiently below rated V_R .

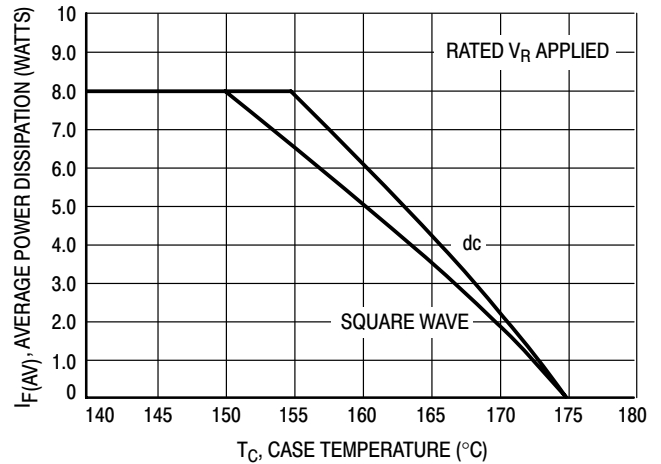

Figure 3. Current Derating, Case, Per Leg

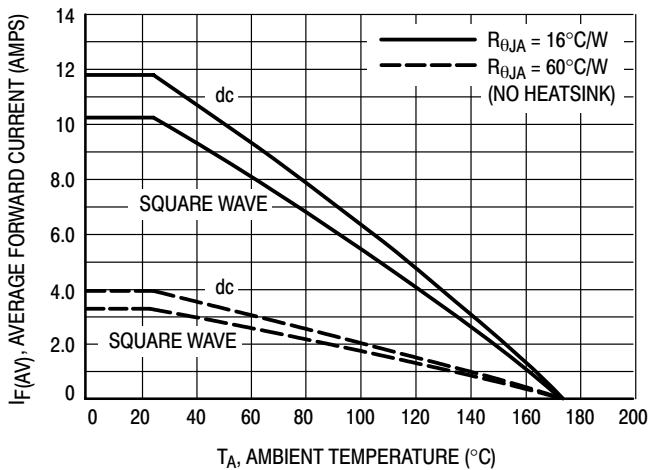

Figure 4. Current Derating, Ambient, Per Leg

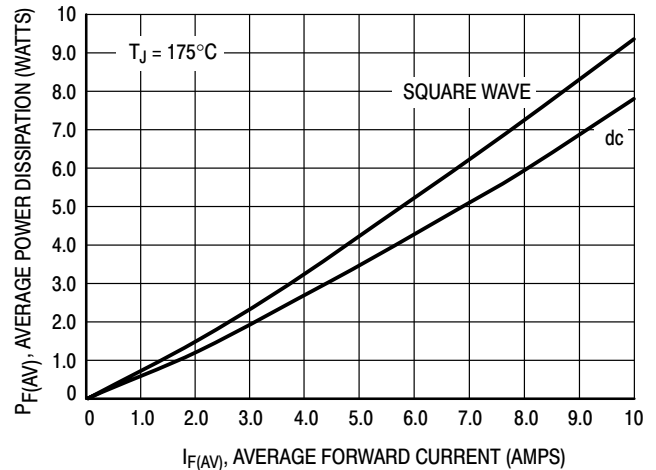
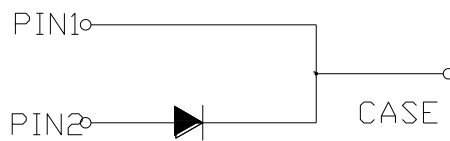
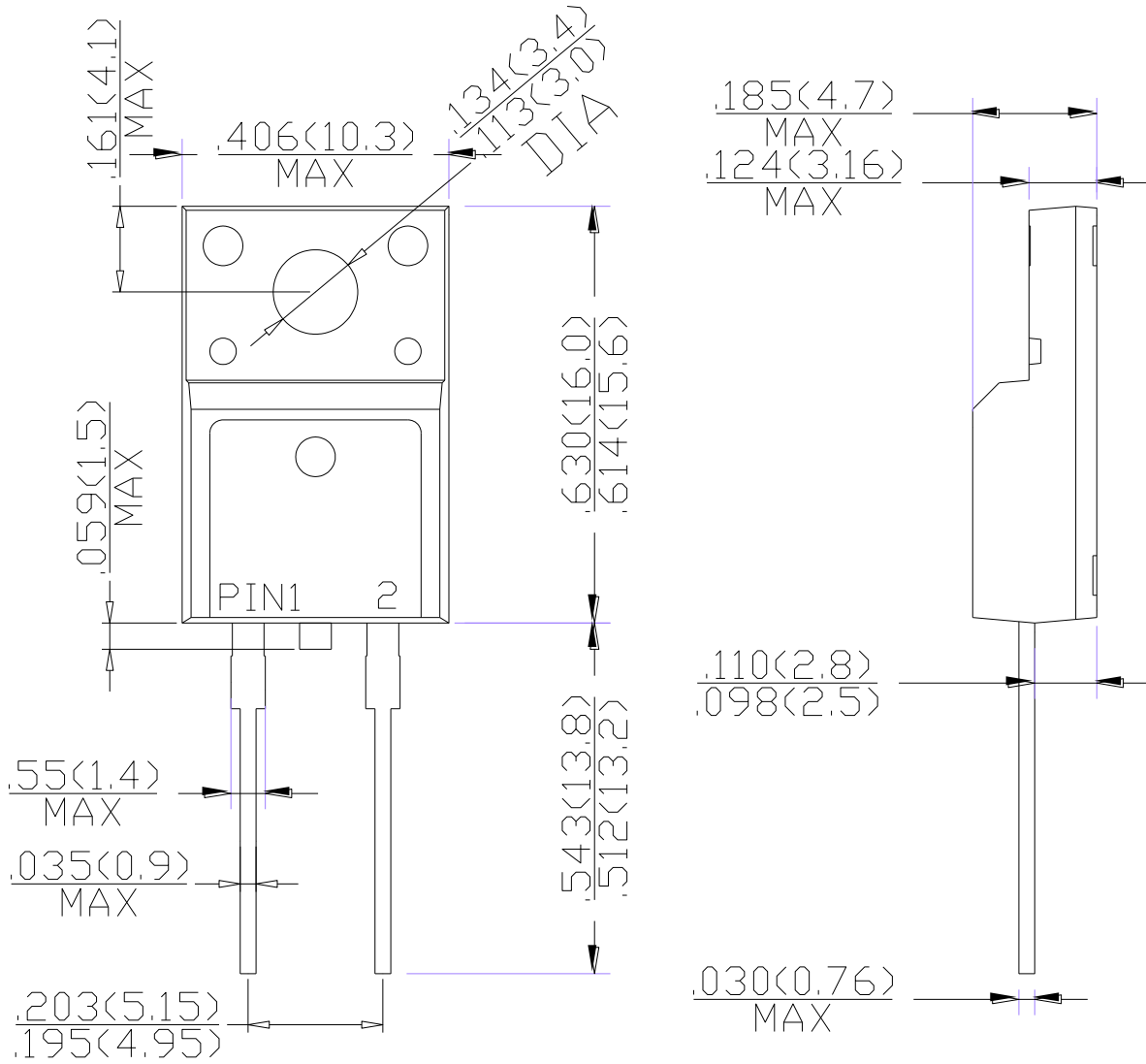

Figure 5. Power Dissipation, Per Leg

Package Dimension

TO-220F -2L



Dimensions in inches and (millimeters)