

TO-220

MUR1610CT-MUR1660CT

Features:

- High surge capacity
- Low Forward Voltage Drop.
- High Current Capability.
- Super Fast Switching Speed For High Efficiency

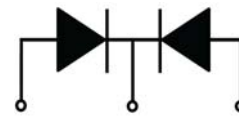
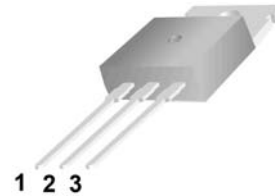

1.Anode 2.Cathode 3. Anode

Absolute Maximum Ratings (Ta=25°C unless otherwise noted)

Parameter	Symbol	MUR 1610 CT	MUR 1615 CT	MUR 1620 CT	MUR 1640 CT	MUR 1660 CT	Unit
Peak Repetitive Reverse Voltage	V_{RRM}	100	150	200	400	600	V
Working Peak Reverse Voltage	V_{RWM}	70	105	140	280	420	V
DC Blocking Voltage	$V_{R(DC)}$	100	150	200	400	600	V
Average Rectified Forward Current Total Device	$I_{F(AV)}$	Per Leg Total Device		8 16			A
Peak Rectified Forward Current Per Diode Leg	I_{FM}	16					A
Nonrepetitive Peak Surge Current(Surge applied at rated load conditions half wave, single phase, 60 Hz)	I_{FSM}	180					A
Operating Junction Temperature and Storage Temperature	TJ, Tstg	-55 to +150					°C
Maximum Thermal Resistance, Junction-to-Case(Per Leg)	$R_{\theta JC}$	3.0		2.0			°C/ W

ELECTRICAL CHARACTERISTICS (Per Diode Leg)

Parameter	Symbol	MUR 1610 CT	MUR 1615 CT	MUR 1620 CT	MUR 1640 CT	MUR 1660 CT	Unit
Forward Voltage (Note 1)($I_F = 8.0 A, T_C = 25^\circ C$)	V_F	1.0		1.3	1.7		V
Maximum Instantaneous Reverse Current (Note 1) (Rated DC Voltage, $T_C = 150^\circ C$) (Rated DC Voltage, $T_C = 25^\circ C$)	I_R	250 10		500 10			μA
Maximum Reverse Recovery Time ($I_F = 0.5 A, I_R = 1.0 A, I_{REC} = 0.25 A$)	T_{RR}	35		35			ns

Note 1.Pulse Test: Pulse Width = 300 μs , Duty Cycle $\leq 2.0\%$

Typical Characteristics

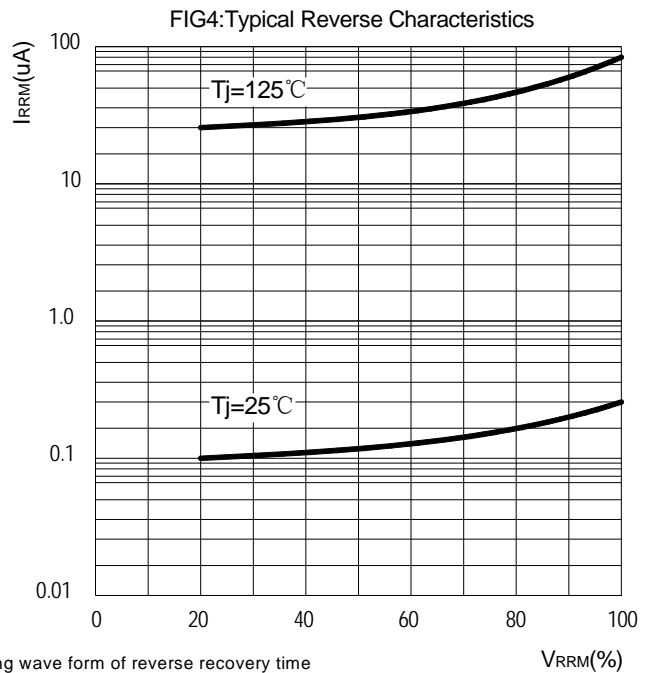
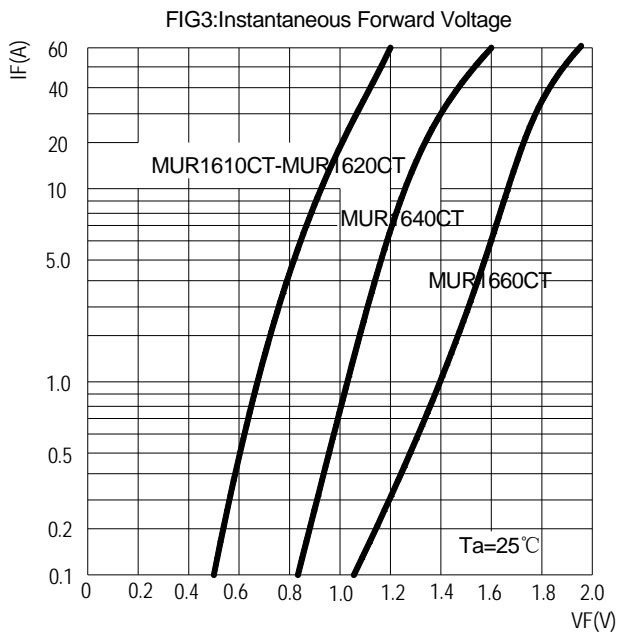
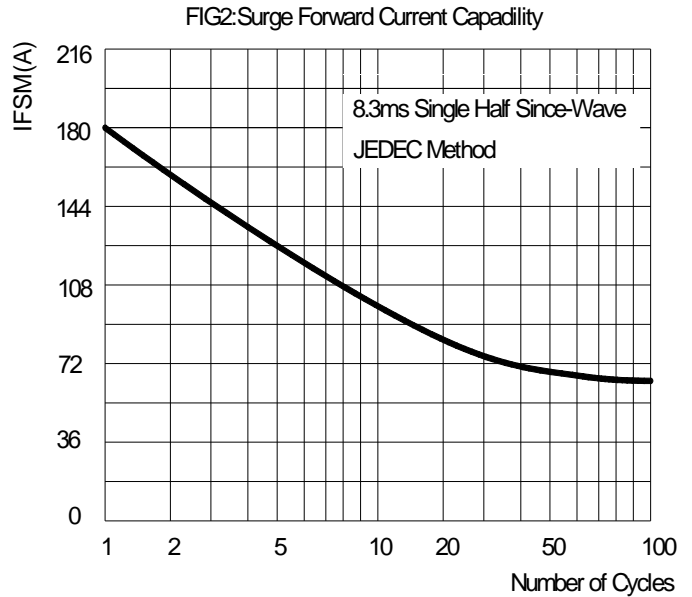
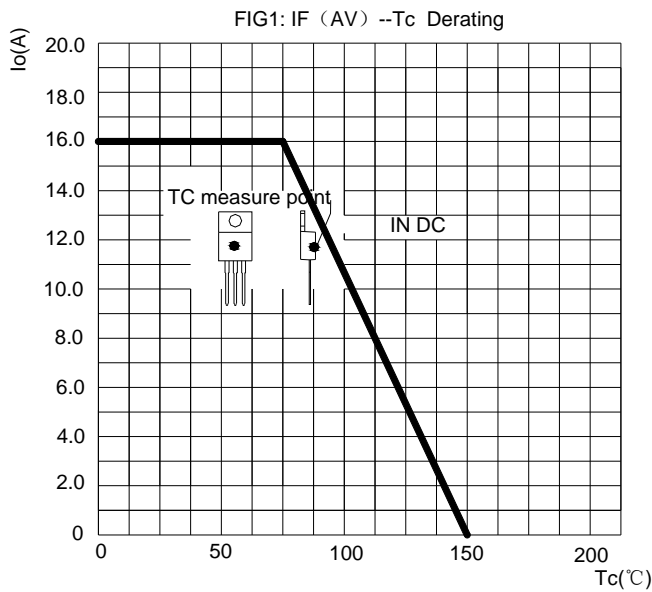
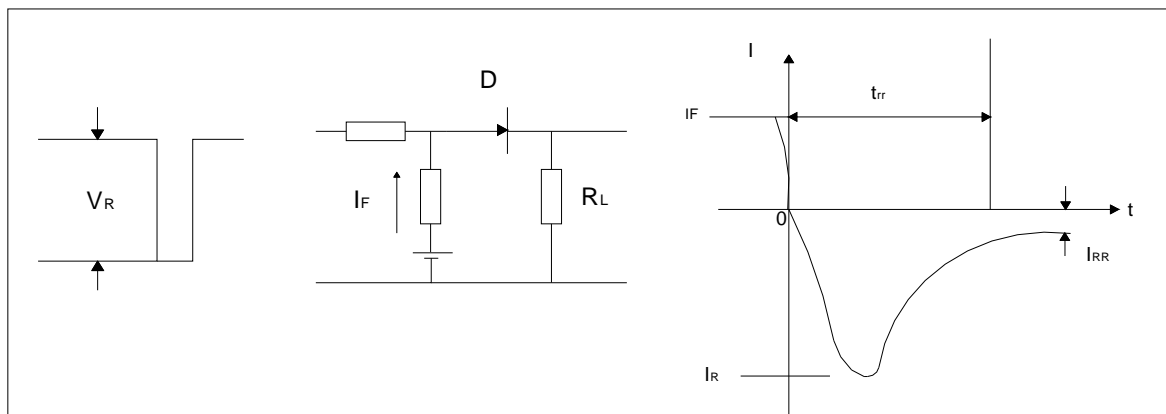

FIG.5: Diagram of circuit and Testing wave form of reverse recovery time



Package Dimension

TO-220

Unit: mm

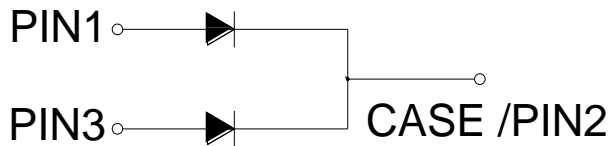
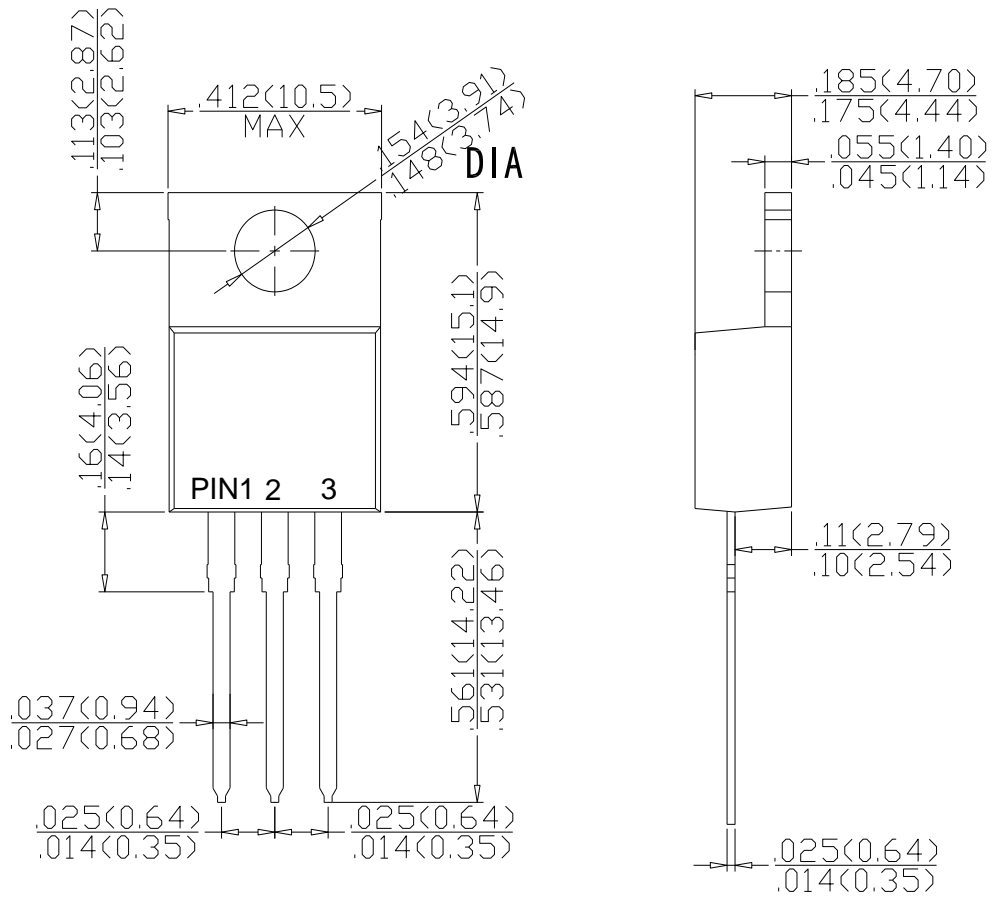

Dimensions in inches and (millimeters)