

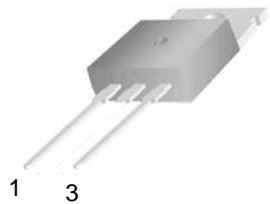

<p>MUR805 – MUR860</p> <p>Features:</p> <ul style="list-style-type: none"> <input type="checkbox"/> High surge capacity <input type="checkbox"/> Low Forward Voltage Drop. <input type="checkbox"/> High Current Capability. <input type="checkbox"/> Super Fast Switching Speed For High Efficiency 	<div style="text-align: right;">  </div> <p style="text-align: center;">TO-220 -2L</p>   <p style="text-align: center;">1. Cathode 3. Anode</p>
--	--

Absolute Maximum Ratings (Ta=25°C unless otherwise noted)

Parameter	Symbol	MUR 805	MUR 810	MUR 815	MUR 820	MUR 830	MUR 840	MUR 860	Unit
Maximum recurrent peak reverse voltage	V_{RRM}	50	100	150	200	300	400	600	V
Maximum RMS Voltage	V_{RMS}	35	70	105	140	210	280	420	V
Maximum DC Blocking Voltage	$V_{R(DC)}$	50	100	150	200	300	400	600	V
Average Rectified Forward Current Total Device, (Rated V_R),	$I_{F(AV)}$	8							A
Nonrepetitive Peak Surge Current(Surge applied at rated load conditions half wave, single phase, 60 Hz)	I_{FSM}	125							A
Operating Junction Temperature and Storage Temperature	T_J, T_{stg}	-55 to +150							°C
Maximum Thermal Resistance, Junction-to-Case	$R_{\theta JC}$	3.0				2.0			°C/W

ELECTRICAL CHARACTERISTICS

Parameter	Symbol	MUR 805	MUR 810	MUR 815	MUR 820	MUR 830	MUR 840	MUR 860	Unit
Forward Voltage (Note 1) ($I_F = 8A, T_j = 25^\circ C$) ($I_F = 8A, T_j = 125^\circ C$)	V_F	0.975			1.30		1.70		V
Maximum Instantaneous Reverse Current (Note 1) (Rated DC Voltage, $T_j = 25^\circ C$) (Rated DC Voltage, $T_j = 150^\circ C$)	I_R	5			10		500		μA
Maximum Reverse Recovery Time ($I_F = 0.5 A, I_R = 1.0 A, I_{REC} = 0.25 A$)	T_{RR}	35							ns

Note 1.Pulse Test: Pulse Width = 300 μ s, Duty Cycle $\leq 2.0\%$

Typical Characteristics

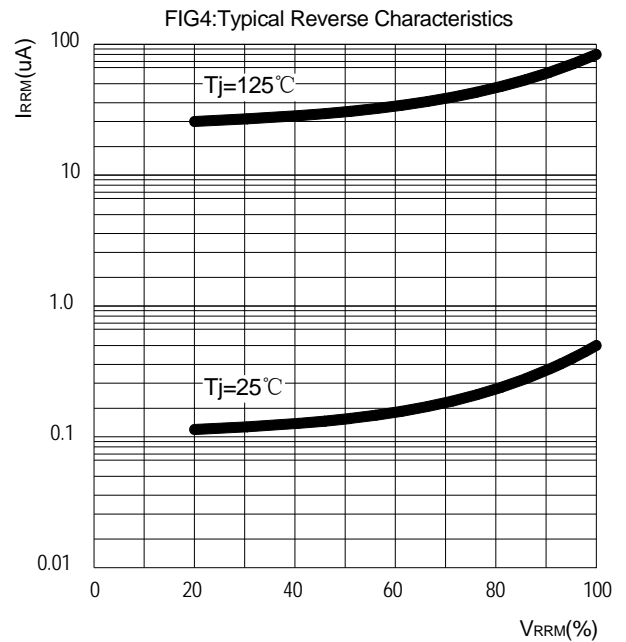
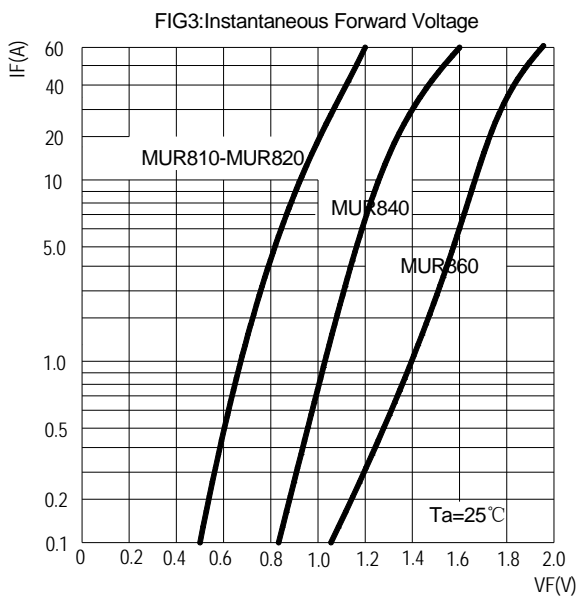
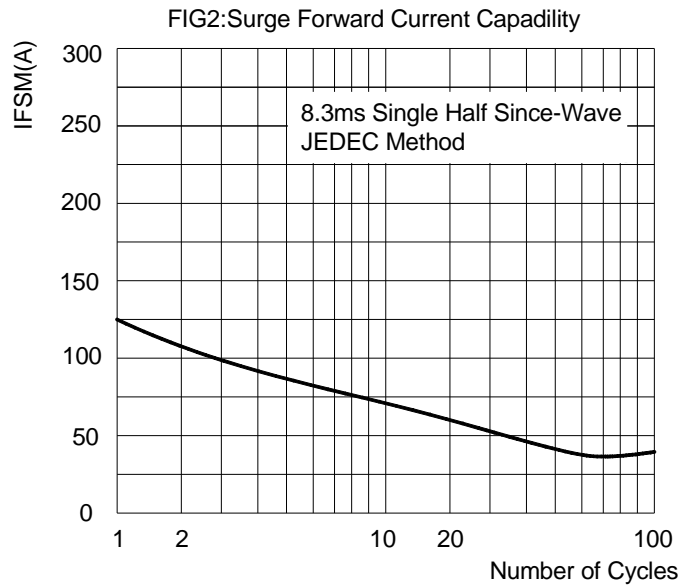
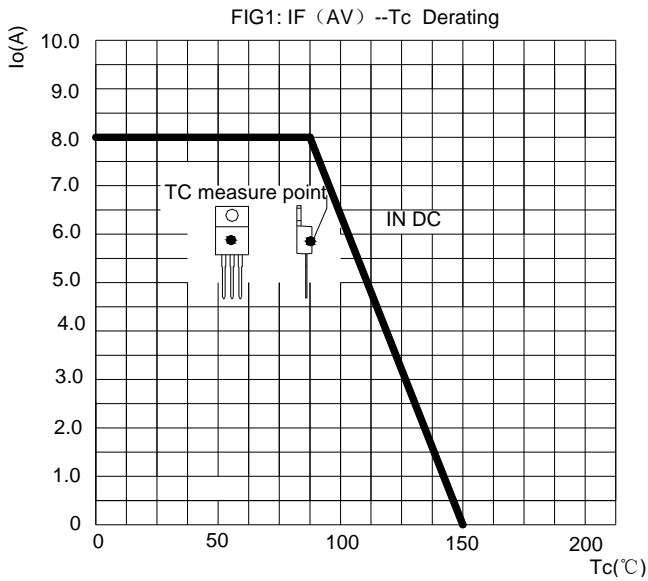
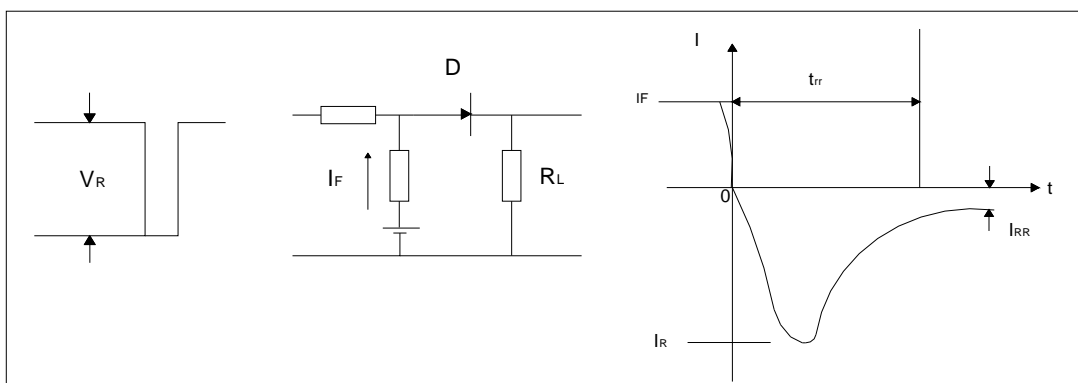
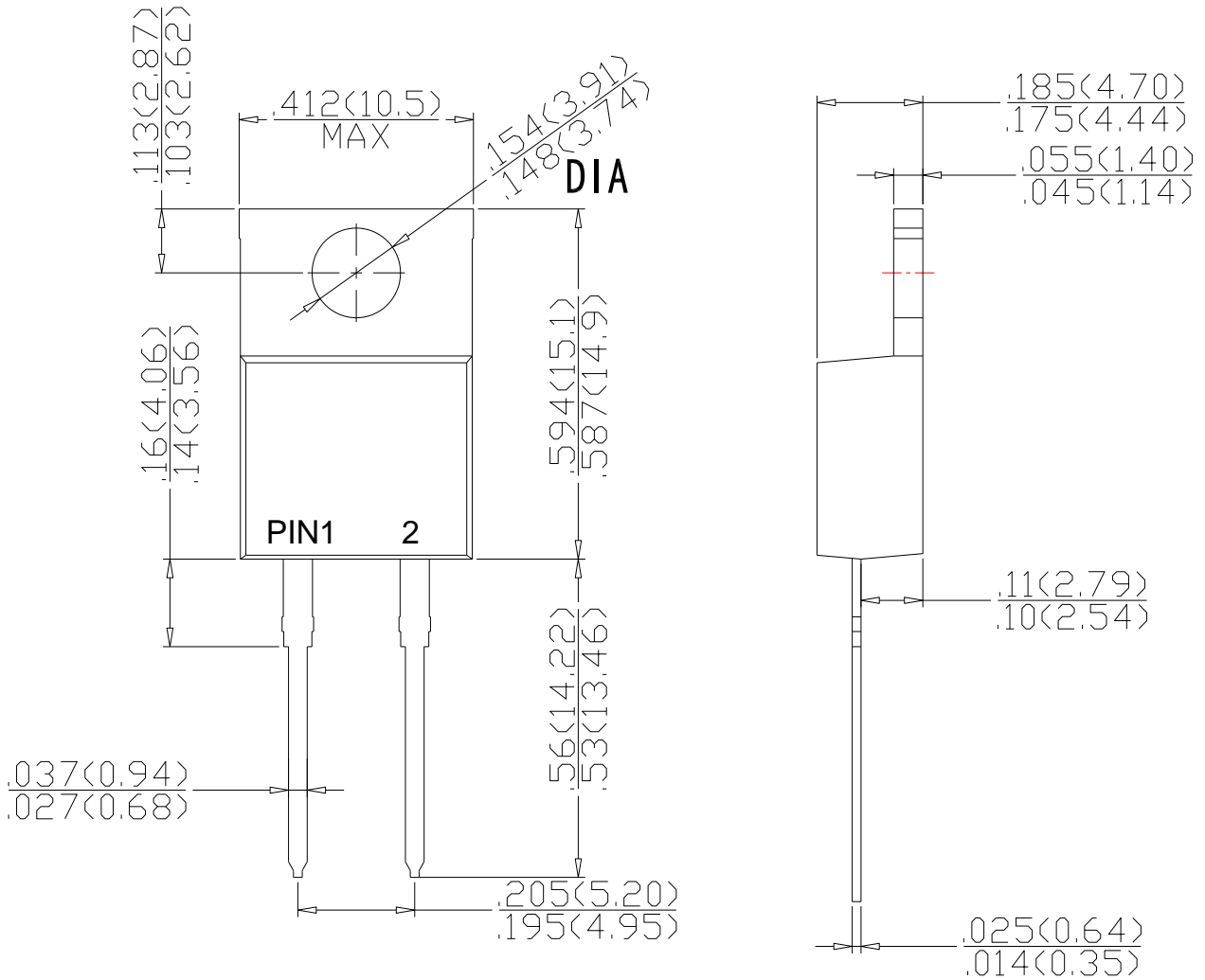

FIG.5: Diagram of circuit and Testing wave form of reverse recovery time



Package Dimension

TO-220 -2L



Dimensions in inches and (millimeters)